

A surface-mounted luminaire features SHARP ZENIGATA CoB LED providing energy-efficient and low-maintenance lighting solutions. General/Accent lighting for concrete and false ceiling for residences, commercial and retail applications.

GLOS PIXEL SQUARE-2 SURFACE-MOUNTED LUMINAIRE

Mounting:	Surface-mounted
Lamp:	SHARP ZENIGATA CoB LED 9W/850lm
CRI:	80 (90 optional)
IP:	IP 20; Indoor
Material:	Die-cast aluminum; powder-coated
Color:	<input type="checkbox"/> WH <input checked="" type="checkbox"/> BK
LED CCT:	3000K

OPTICAL

Optics:	Reflector
Beam angle:	60
Distribution:	Symmetrical

ELECTRICAL

Gear:	LED driver
Voltage(V):	220-240
Rated current:	250mA
Dimming:	-

PHOTOMETRIC

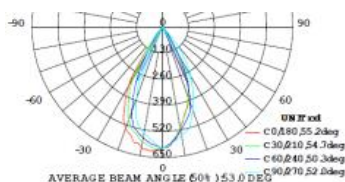

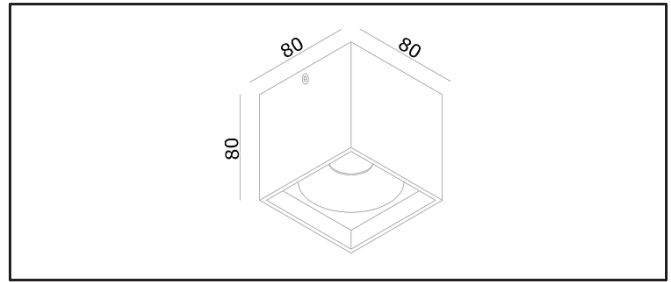

A surface-mounted luminaire features SAMSUNG AC4W LED providing energy-efficient and low-maintenance lighting solutions. General/Accent lighting for concrete and false ceiling for residences, commercial and retail applications.

GLOS PIXEL SQUARE-I SURFACE-MOUNTED LUMINAIRE

Mounting:	Surface-mounted
Lamp:	SAMSUNG AC4W/300lm
CRI:	80 (90 optional)
IP:	IP 20; Indoor
Material:	Die-cast aluminum; powder-coated
Color:	<input type="checkbox"/> WH <input checked="" type="checkbox"/> BK
LED CCT:	3000K

OPTICAL

Optics:	Reflector
Beam angle:	40
Distribution:	Symmetrical

ELECTRICAL

Gear:	(Not required)
Voltage(V):	220-240
Rated current:	-
Dimming:	-

PHOTOMETRIC

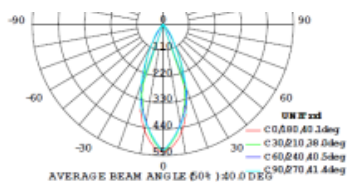

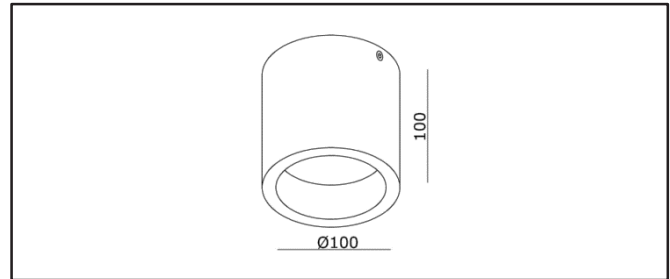

A surface-mounted luminaire features SHARP ZENIGATA CoB LED providing energy-efficient and low-maintenance lighting solutions. General/Accent lighting for concrete and false ceiling for residences, commercial and retail applications.

GLOS PIXEL ROUND-2 SURFACE-MOUNTED LUMINAIRE

Mounting:	Surface-mounted
Lamp:	SHARP ZENIGATA CoB LED 9W/850lm
CRI:	80 (90 optional)
IP:	IP 20; Indoor
Material:	Die-cast aluminum; powder-coated
Color:	<input type="checkbox"/> WH <input checked="" type="checkbox"/> BK
LED CCT:	3000K

OPTICAL

Optics:	Reflector
Beam angle:	60
Distribution:	Symmetrical

ELECTRICAL

Gear:	Integral LED driver
Voltage(V):	220-240
Rated current:	250mA
Dimming:	-

PHOTOMETRIC

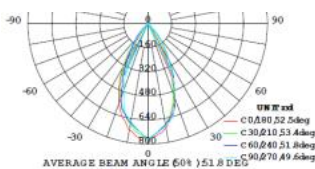

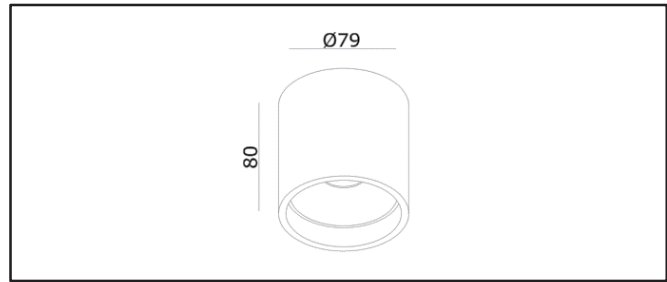

A surface-mounted luminaire features SAMSUNG AC4W LED providing energy-efficient and low-maintenance lighting solutions. General/Accent lighting for concrete and false ceiling for residences, commercial and retail applications.

GLOS PIXEL ROUND-I SURFACE-MOUNTED LUMINAIRE

Mounting:	Surface-mounted
Lamp:	SAMSUNG AC4W/300lm
CRI:	80 (90 optional)
IP:	IP 20; Indoor
Material:	Die-cast aluminum; powder-coated
Color:	<input type="checkbox"/> WH <input checked="" type="checkbox"/> BK
LED CCT:	3000K

OPTICAL

Optics:	Reflector
Beam angle:	40
Distribution:	Symmetrical

ELECTRICAL

Gear:	(Not required)
Voltage(V):	220-240
Rated current:	-
Dimming:	-

PHOTOMETRIC

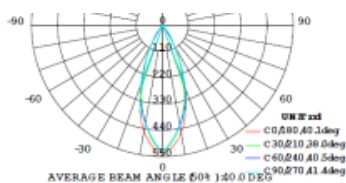

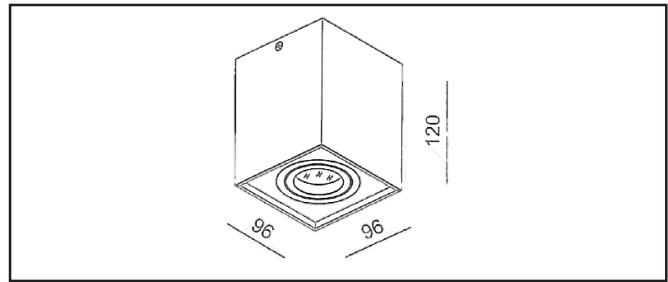

A surface-mounted LED luminaire features single halogen MR-16 or GU-10 module, suitable for various halogen lamp-source and LEDs. Easy maintenance to remove lamps after installation.

Elegant design with 0°-20° tilt angle to maximize lighting range.

General/Accent lighting for museums, exhibitions, art galleries, showrooms and commercial applications.

GLOS NIXON-SQ SURFACE-MOUNTED LUMINAIRE

Mounting:	Surface-mounted
Lamp:	MR-16 (QR-CBC51)
IP:	IP 20; Indoor
Material:	Aluminum
Color:	<input type="checkbox"/> WH <input checked="" type="checkbox"/> BK <input type="checkbox"/> SV

OPTICAL

Optics:	Direct
Beam angle:	(Subject to lamp-source)
Distribution:	Symmetrical

ELECTRICAL

Gear:	Electronic transformer
Voltage(V):	220-240
Input current:	12V
Dimming:	



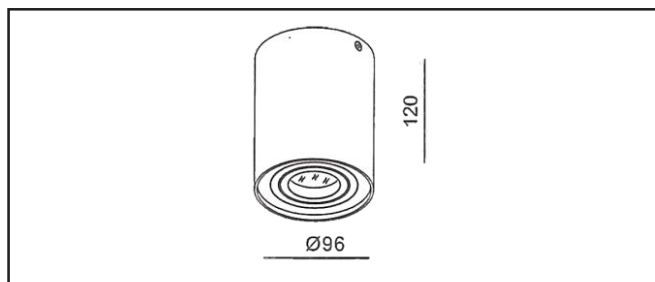

A surface-mounted LED luminaire features single halogen MR-16 or GU-10 module, suitable for various halogen lamp-source and LEDs. Easy maintenance to remove lamps after installation.

Elegant design with 0°-20° tilt angle to maximize lighting range.

General/Accent lighting for museums, exhibitions, art galleries, showrooms and commercial applications.

GLOS NIXON-RD SURFACE-MOUNTED LUMINAIRE

Mounting:	Surface-mounted
Lamp:	MR-16 (QR-CBC51)
IP:	IP 20; Indoor
Material:	Aluminum
Color:	□ WH ■ BK ■ SV

OPTICAL

Optics:	Direct
Beam angle:	(Subject to lamp-source)
Distribution:	Symmetrical

ELECTRICAL

Gear:	Electronic transformer
Voltage(V):	220-240
Input current:	12V
Dimming:	



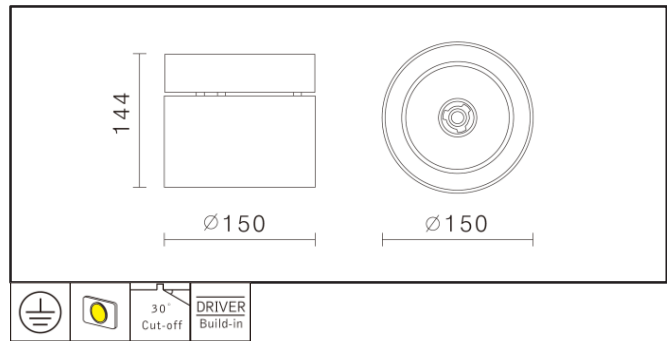

Simple and clean design surface-mounted luminaire features SHARP ZENIGATA CoB LED providing energy-efficient and low-maintenance lighting solutions. Available in two shapes; round and square, with built-in driver and easy installation process.

General lighting or guide for retail spaces, public area and commercial applications.

GLOS CYLIN-2 SURFACE-MOUNTED LUMINAIRE

- Mounting: Surface-mounted
- Lamp: SHARP ZENIGATA CoB LED 32W (900mA)/3600lm
- CRI: 80 (90 optional)
- IP: IP 20; Indoor
- Material: Aluminum, paint
- Color: WH BK SV
- LED CCT: CW NW WW

OPTICAL

- Optics: Reflector
- Beam angle: 12/20/40/70
- Distribution: Symmetrical



ELECTRICAL

- Gear: Integral LED Driver
- Voltage(V): 220-240
- Rated current: 900mA
- Dimming: Yes (optional)

PHOTOMETRIC

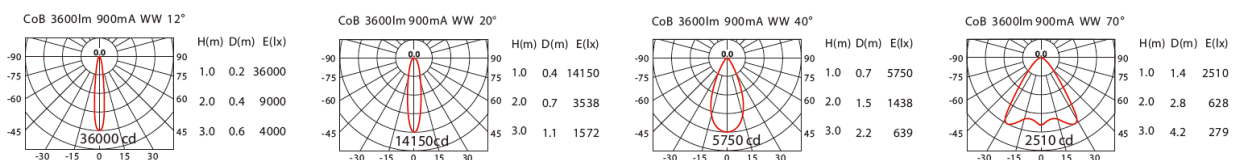

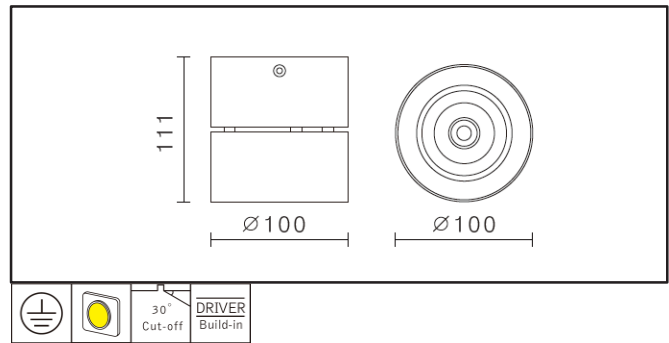

Simple and clean design surface-mounted luminaire features CREE CoB LED providing energy-efficient and low-maintenance lighting solutions. Available in two shapes; round and square, with built-in driver and easy installation process.

General lighting or guide for retail spaces, public area and commercial applications.

GLOS CYLIN-I SURFACE-MOUNTED LUMINAIRE

- Mounting: Surface-mounted
- Lamp: CREE CoB LED 19.5W (500mA)/1800lm
- CRI: 80 (90 optional)
- IP: IP 20; Indoor
- Material: Aluminum, paint
- Color: WH BK SV
- LED CCT: CW NW WW

OPTICAL

- Optics: Reflector
- Beam angle: 12/20/50
- Distribution: Symmetrical



ELECTRICAL

- Gear: Integral LED Driver
- Voltage(V): 220-240
- Rated current: 500mA
- Dimming: Yes (optional)

PHOTOMETRIC

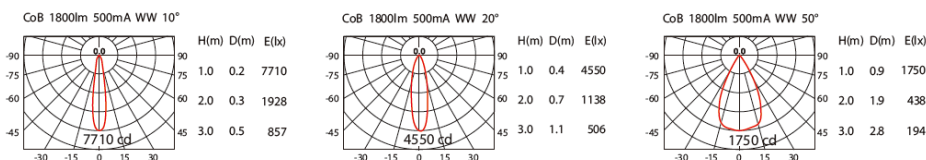

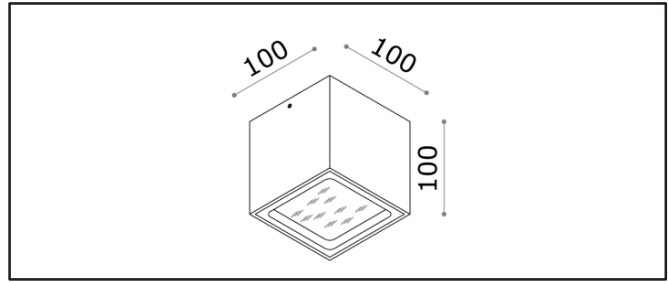

A surface-mounted luminaire features SHARP ZENIGATA CoB LED providing energy-efficient and low-maintenance lighting solutions. General lighting for concrete and false ceiling for residences, commercial and retail applications.

GLOS CL-6244II SURFACE-MOUNTED LUMINAIRE

- Mounting: Surface-mounted
- Lamp: SHARP ZENIGATA CoB LED 15W/1350lm
- CRI: 80 (90 optional)
- IP: IP 20; Indoor
- Material: Die-cast aluminum; powder-coated
- Color: WH BK
- LED CCT: 3000K

OPTICAL

- Optics: Reflector
- Beam angle: 120
- Distribution: Symmetrical

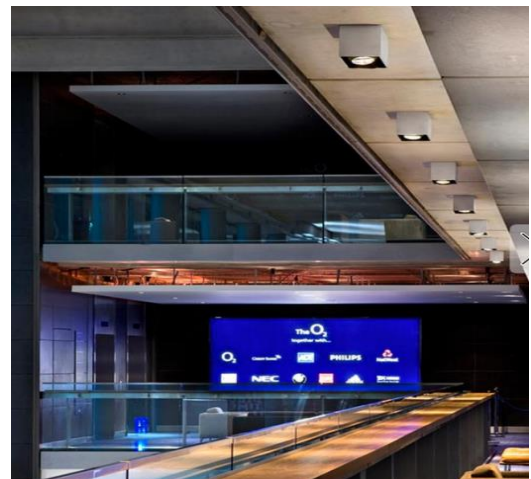

ELECTRICAL

- Gear: GLP15CR LED driver
- Voltage(V): 220-240
- Rated current: 250mA
- Dimming: -

PHOTOMETRIC

